

Installation instructions

CLIC *it!* installation system



	Laminate Flooring			Comfort Flooring	Design-Flooring GreenTec
	Standard	Aqua CLIC <i>it!</i>	Aqua+		
Floating installation	✓	✓	✓	✓	✓
Full-surface bonding	x	x	✓	x	✓
Integrated underlay mat	x	x	x	✓	✓
Separate underlay mat	✓	✓	✓	x	x
Installable surface size without transition profile	10 m x 10 m		15 m x 15 m	10 m x 10 m	15 m x 15 m
Takeover of construction joints	✓	✓	✓	✓	✓
Suitability for bathrooms	x	✓*	✓	x	✓
Suitability for underfloor heating**	✓	✓	✓	✓	✓

*private bathrooms and kitchens/ **electric underfloor heating, see "Substrates with restricted suitability"

1. Inspection and due diligence requirement

The floors are manufactured in highly precise work steps on the most modern production facilities and are subjected to strict quality checks. Irrespective of the intensive quality controls, damage to individual elements, e.g. due to transport, cannot be completely ruled out. Accordingly, the flooring elements must be checked for possible defects before and during installation. Damaged flooring boards or those that differ from the norm should not be installed but returned to the supplier to be replaced.

2. Subfloor

2.1 As a rule, the following applies:

- the subfloor is ready for installation, i.e. it is dry, clean, free of separating agents, free of cracks, resistant to tension and pressure and level for the completion of flooring work.
- the increased requirement of ≤ 2 mm/m must be complied with in terms of levelness.
- the contractor for floor covering work must, within the scope of the inspection and due diligence requirement, verify prior to installation that the subfloor has the required readiness for covering and must register "concerns" in writing if the subfloor is not ready for covering, i.e. has defects and/or there is a risk of damage to the top floor due to its construction.

The following points in particular must be taken into account when assessing the installation suitability for EGGER floors. In the case of failure to comply, all guarantee and warranty claims will become void.

Inspections of the moisture level of the subfloor

The inspections of the subfloor moisture must be carried out to determine whether the subfloor is sufficiently dry. Installation suitability is determined by measuring the water content in CM %. When carrying out inspections with the CM device (calcium carbide method), the following thresholds must not be exceeded:

	Cement screed*	Calcium sulphate screed*
without surface heating	< 2.0 CM %	< 0.5 CM %
with surface heating (heated screed)	< 1.8 CM %	< 0.3 CM %

*These values apply to screeds without additives. With the use of additives and in case of fast-drying screed, the measurements and limits specified by the respective manufacturer shall apply.

In some countries/regions, installation suitability is determined by measuring the corresponding relative humidity, as described below.

	Threshold
KRL measurement	< 75% rH for unheated screed and < 65% rH for heated screed
BS 5325	< 75% rH (surface measurement, United Kingdom)
NT Built 439	< 85% rH (Scandinavia)
ASTM F2170	< 80% rH (SITU sample, North America)

Inspections of the levelness of the subfloor

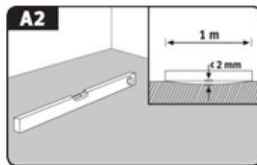

The levelness inspections are based on common standards and are conducted by placing a yardstick/straight-edge on the high points of the surface and determining the gauge at the deepest location in relation to the bearing surfaces (measuring point intervals). A max. 2 mm gauge (vertical deviation) is admitted at 100 cm measuring intervals. Larger deviations should be addressed by suitable measures (e.g. with self-levelling compounds).

Inspections of the strength/load-bearing capacity of the subfloor

The subfloor must be a sealed, self-supporting layer.

Inspections of the cleanliness of the subfloor

The subfloor must be kept clean and be in a vacuum-cleaned condition.

Inspections of the atmospheric conditions

The following conditions should be met prior to, during and after installation:

- an air temperature of min. 18 °C
- a floor surface temperature of min. 15 °C
- A relative air humidity of between 40% and 70%.

2.2 Suitable subfloors

All subfloors are considered suitable for the floating installation of flooring if they are suitable for installation in accordance with the above-mentioned requirements. In particular, these include:

- All types of screed including hot water-heated screed
- Woodfibre boards, OSB and chipboard structures
- Existing floor coverings such as ceramic tiles.

Screeds with hot-water floor heating (heated screeds)/ floor cooling

When preparing a heated flooring construction, all those involved (builder, architect, specialist heating planner, heating engineer, installer, floor covering manufacturer) must work together in a coordinated manner. All surface-heated flooring requires appropriate planning and coordination of the heating system and screed to ensure maximum long-term performance without causing any damage. Alongside the usual inspections on the installation subfloor, the underfloor heating/cooling function must be inspected (functional heating/cooling). This evidence of the screed construction being properly heated up and cooled down must be provided each season and be documented by means of a heating and cooling protocol.

When heating the load and heat distribution layer, a distinction is made between functional heating and floor curing heating.

- Functional heating is the proof of the heating installer that a proper structure has been built and is used to review the functionality of heated flooring structures.
- Floor curing heating is the expelling of the residual moisture in the screed until installation suitability is reached.
- **Attention!** Functional heating does not guarantee that the screed has reached the residual moisture required for installation suitability. Accordingly, floor curing heating is necessary as a rule.
- The flooring is generally installed "floating". When installing floating on heated screed, attention should be paid to the heat conductivity values of the flooring and the insulating underlay. The total of the heat conductivity values for all components must be $< 0.15 \text{ m}^2\text{K/W}$. When using insulating underlays that are not from the range of accessories, any guarantee is rejected with regards to compliance with the effective maximum permitted heat conductivity of the overall structure for a floating installation on heated screeds.
- The surface temperature of the heated floor construction must not exceed $28 \text{ }^\circ\text{C}$, and excessively rapid heating processes must be avoided.
- Installation on surface heating systems with night storage function is not permitted.

Subfloors with a limited degree of suitability

Electric panel/foil heating systems are considered suitable substrates to a limited extent.

The flooring may only be installed on electric surface / foil heating systems that:

- are equipped with temperature sensors and controllers
- are of a recent design and have the technical approval of the heating manufacturer for flooring
- are installed full-surface – individual partial sections (e.g. a partial installation only in the walking areas in the bedroom) are not approved so as to avoid heat gradients in the floor area and to ensure an even heat distribution
- are not night storage heaters and if,
- in the case of foil heating systems, an underlay mat with a maximum thickness of 3 mm and a pressure stability of at least CS 60 kPa is installed (according to the installation instructions of the respective heating manufacturer)
- in the case of electric mat heaters (mesh), these have been implemented in the screed (in accordance with the installation instructions of the respective heater manufacturer).

Unsuitable subfloors

The floors may never be installed on textile floor coverings. Textile floor coverings (PVC, cushion vinyl, linoleum) and carpets are unsuitable in terms of stability and hygiene and must be removed. In the case of a failure to comply, any guarantee and warranty claims will become void.

Mineral subfloors

For floating installation of flooring on mineral subfloors (screeds, heated screeds, tiles, etc.), a moisture protection film with SD value > 75 m must always be installed as a vapour barrier over the entire surface and in a trough shape. When professionally installed, the moisture protection film must overlap by 5-20 cm in the joining areas depending on the design. To improve the impact noise insulation, a system-specific insulation underlay must be placed on top. When using Silenzio Duo, Silenzio Easy SD or a comparable 2-in-1 insulation underlay with integrated moisture protection, no separate moisture protection film is required.

Subfloors made of wood (OSB, chipboard and fibreboard, real wood flooring boards)

Any loose flooring boards or other types of boards should be properly screwed down. The flooring boards are to be installed at right angles to the longitudinal direction of the wooden flooring boards.

To improve the impact noise insulation, a system-specific insulation underlay should be installed under flooring.

The flooring with Silenzio underlay mat laminated on the back is installed directly on top of the wood-based flooring boards or wooden flooring boards.

Attention!

- Do not place moisture protection film on wooden subfloors.
- A system-specific Silenzio underlay mat must be used under Laminate flooring.
- For flooring with Silenzio pad attached, no further impact noise insulation underlay may be installed.

Wet rooms/damp areas

The standard Laminate and Comfort Flooring is not suitable for installation in wet and damp areas such as bathrooms, shower rooms, saunas or outdoors. In the case of a failure to comply, any guarantee and warranty claims will become void.

Exceptions are the Design Flooring Green *Tec*, the Laminate Flooring Aqua+ and Laminate Flooring Aqua CLIC *it!*.

These products can also be installed in bathrooms with normal household use without a floor drain with bath tub or shower tray where the floor surface is only temporarily and briefly exposed to splashing water.

3. Prior to installation

Conditioning the boards

Before starting installation, the flooring packages must be stored in the room where they will be installed or in a room with the same climate conditions. Acclimatisation takes place in the following conditions:

- Packaged
- For a period of at least 48 hours
- laid flat, a minimum of 50 cm from all walls
- the room temperature is at least 18 °C
- the surface temperature of the floor is at least 15 °C
- At a relative atmospheric humidity of between 40% and 70%.

Tools and protective equipment

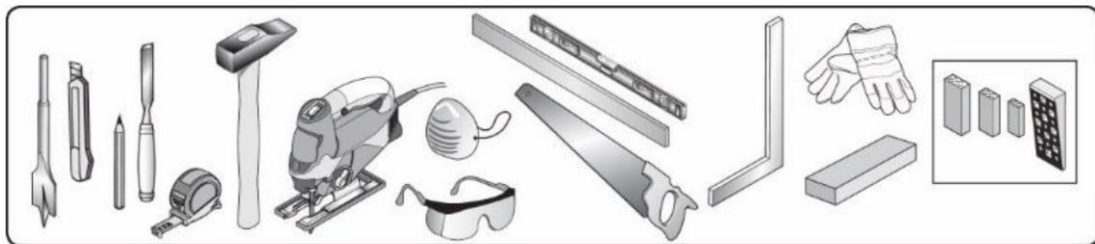

- electric jigsaw, circular or chop saw, laminate cutter and cutter knife
- if necessary, drill and metal saw for fixing/cutting floor profiles and skirting boards
- folding rule, angle and pencil
- tapping block, hammer and possibly a crowbar
- spacer
- Wear suitable protective equipment such as safety goggles, dust mask and gloves.

Direction of installation

The flooring works best when the flooring boards are installed parallel to the incidence of light. However, there are binding requirements for the direction of installation only for subfloors made of wooden flooring boards or strip parquet/wooden floors arranged in brick bond.

In these cases, the flooring must be installed at right angles to the longitudinal direction of the flooring boards/strip parquet.

Built-in kitchens/built-in cabinets

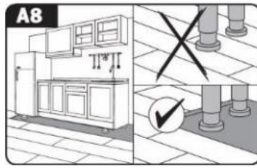

Kitchen units as well as fixed and/or heavy built-in cabinets must not be installed on floors so that no one-sided fixing of the floor surface occurs (exceptions are free-standing kitchen islands). It is recommended to install floor covering only up to behind the skirting panel, so that the flooring can be easily removed at any time.

If this is not possible, the following alternatives are available:

A) Decoupling:

1. install the floor over the entire surface and assemble the kitchen unit/built-in cupboard
2. decouple the flooring surface by sawing between the furniture feet and the skirting panel
3. cover with a floor profile or leave open (no visible area)

B) Bolt circle drill (\varnothing furniture foot + 16 mm):

1. install the floor over the entire surface
2. Determine the position of the furniture feet, mark them on the flooring and saw them out using a bolt circle drill
3. Assemble the kitchen unit/built-in cupboard.

Planning the first and last row

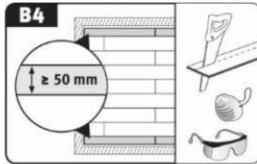

Prior to installation, the room must be measured to determine whether the width of the first row should be reduced. This is always necessary if the last row would mathematically be narrower than 5 cm and/or to give the first and last row the same width.

Wall distance and expansion gaps

The flooring – like all wood-based floors – is subject to a certain motion behaviour due to changing room climate conditions. Due to this material-specific motion behaviour, edge/wall joints must be installed for all fixed structures such as walls, door frames, pipe penetrations, pillars and stairs. In addition, motion joints must always be installed in the following surface areas and surface sizes:

- Door thresholds
- Passageways
- Angled areas (L-shaped rooms)
- Laminate and Comfort Flooring: room lengths and/or widths of more than 10 m.
- Design Flooring GreenTec and Laminate Flooring Aqua+: room lengths and/or widths of more than 15 m.

Sufficiently dimensioned edge / wall joints and motion joints, with a width of at least 8-10 mm, do not impede the motion of the installed floor surface. The guiding formula is as follows: 1.5 mm expansion gap (circumferential) per metre of floor surface (for example: 10 m room length = 15 mm wall distance to both walls).

The wall and motion joints are covered by skirting board and/or corresponding floor profiles.

Note: With most types of profile, the base (sub-profile) taking the cover profile (upper profile) must be installed prior to installing the flooring.

4. Installation

4.1. Basic information

- The installation must be carried out in daylight or suitable/sufficient lighting. The flooring elements must be checked for possible faults prior to and during installation. Flooring boards with visible damage or defects must not be installed.
- The flooring is installed "floating", i.e. without fixing (no bonding/screwing, etc.) the flooring boards to the subfloor. With floating installation, the individual flooring boards are installed using the CLIC *it!* locking system to connect and place the individual boards.

Note: Exceptions are the Design Flooring GreenTec and Laminate Flooring Aqua+, as these can also be bonded over the entire surface (for details, see "Full-surface bonding").

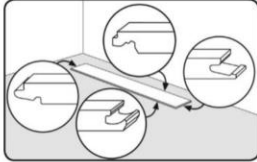

- Make sure that you understand the difference between the tongue and groove on the board.
 - Start installing in a left-hand corner of the room with both tongue sides of the first board facing the wall and both grooved sides facing the installer.
 - The short ends (header joints) must be staggered at least 20 cm or ≥ 50 cm for the "Long" format.
-
- In case of products supplied with factory-produced bevel and/or with special design (e.g. tile decor), ensure the short end/header joint is even according to the bevel and/or pattern configuration.
 - Remaining pieces can be used as the start or end board of each row if they are at least 20 cm long (> 50 cm for the "Long" format), and thus the minimum offset of the head joints from row to row is maintained.
 - To prepare the last row of boards for installation, take the board and place it exactly on top of the row before last. By means of a residual board (board width), it is possible to transfer the wall structures to the board within a pre-chosen distance.
 - When cutting to size by using a circular, plunge or cross-cut saw, place the flooring boards with the decor side facing upwards. When cutting to size by using jigsaw, move it over the back of the board.

4.2. Installation methods

Installing flooring using the CLIC *it!* installation system can be carried out in three different ways:

- Method A: angled in at the short and long side (board by board)
- Method B: angled in at the long side and tapped in at the short board by board
- Method C: installation in rows by angling along the short and long sides

4.2.1. Installation method A:

Angled in at the short and long side board by board

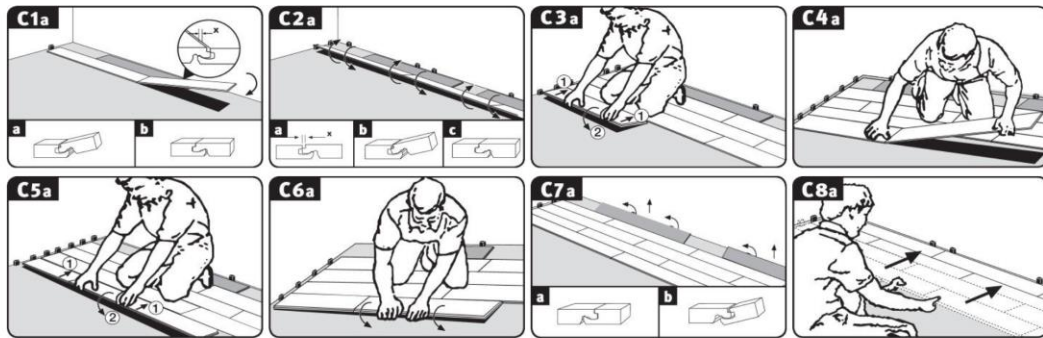

- Place the first board in the left-hand corner of the room so that both tongue sides face the wall.
- Join the boards of the first row by angling the short tongue of the board to be installed diagonally from above into the short groove of the already installed board and lay it down with slight pressure on the short end. The last board in the first row is marked and cut to the required length and installed as specified above (Fig. C1a).
- Make sure that the boards of the first row are aligned with precision on the long side. It is recommended to place a piece of the flooring as a stop/spacer between the wall and the first row, respectively in the area of the short joints. After the first 2-3 rows have been installed, remove the boards acting as stops, and align the flooring area installed up to this point with the wall, maintaining the distance from the wall and inserting the spacers.

Angle in the first board of the second and each subsequent row lengthwise diagonally from above with the tongue in the groove of the previously installed row and lay it down with slight pressure (Fig. C3a).

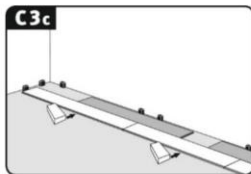

Attention! After locking the boards lengthwise, tap with a suitable tapping block to ensure complete locking.

- Install all subsequent boards of a row as follows:
 - Angle in the front tongue at an angle from above into the front groove of the previously installed board and lay the board (with light pressure on the front side) as close as possible to the long edge of the installed row (Fig. C4a).
 - Slightly lift the board to be installed on the long side (Fig. C5a).
 - Now click the tongue on the long side diagonally from above into the groove of the previous row (push in) and lower the board, thus closing the long side joint (Fig. C6a).

Note: Please note that when lifting and angling the board on the long side, the adjacent board on the left is automatically lifted as well due to the already locked front end.
 - Make sure that all joints are completely closed, i.e. that no joints are visible. If there are isolated, smaller joints, these can be closed by slight, controlled tapping with a tapping block.

Install all remaining boards as described above, adjusting the length of the first and/or last board of any row if necessary.

4.2.2. Installation method B:

Angled in at the long side and tapped in at the short board by board

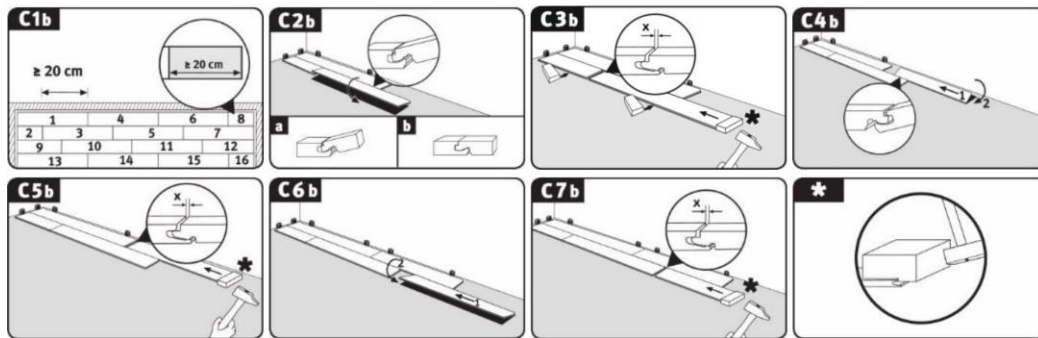

- The boards in the first two rows can be installed simultaneously, which means constantly alternating them whilst complying with the minimum step joint of the end joints (Fig. C1b).

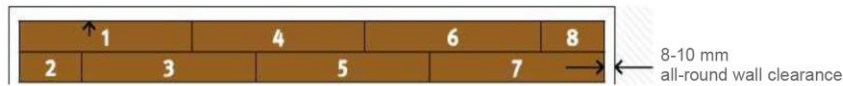

- Board 1 = lay out in a left-hand corner of the room so that both tongue sides face the wall.
- Board 2 = angle in the long side of this board, which has been cut to length.
 - ✓ For this purpose, place the longitudinal tongue at a slight angle from above into the longitudinal groove of board 1 and lower board 2.
- Board 3 = Angle in the long side and tap in on the short side of the decor edging (do not hit!).
 - ✓ To begin with, place the longitudinal tongue at a slight angle from above into the longitudinal groove of board 1 (Fig. C2b).
 - ✓ In this angled position, push board 3 as close as possible to the short end of board 2 so that the short tongue of board 3 lies on the short groove of board 2 (Fig. C3b).
 - ✓ Then lock the longitudinal joint by lowering board 3 and tap on the long side.
 - ✓ Lock the front connection by tapping it horizontally into the decor edge using a hammer and tapping block (Fig. C3b).

Note:

- ✓ To adjust the height level, it is recommended to place a flooring board on the long side in the area of the heading point.
- ✓ Excessive hammering can lead to damage to the joint, which may only become apparent later in the course of use.
- Board 4 = opposite longitudinal angling and tapping of the short side as above.
 - ✓ Place the longitudinal groove at a slight angle under the longitudinal tongue of board 3 (Fig. C4b).
 - ✓ In this angled position, push board 4 as close as possible to the short end of board 1 so that the short tongue of board 4 lies on the short groove of board 1 (Fig. C4b).
 - ✓ Then lock the longitudinal joint by lowering board 4. (Fig. C4b).

Attention! After locking the boards lengthwise, tap with a suitable tapping block to ensure complete locking.

✓ Lock the front connection by tapping it horizontally into the decor edging using a hammer and tapping block (Fig. C5b).

- Board 5 = longitudinal angling and tapping on the short end (see board 3)
- Board 6 = longitudinal angling and tapping on the short end (see board 4)
- Board 7 = longitudinal angling and tapping on the short end (see board 3)
- Board 8 = longitudinal angling and tapping on the short end (see board 4)
- Install all remaining boards of the first two rows as described above, by cutting the length of the first and/or last board of any row to the necessary size.
- Subsequently position the first two rows while observing the wall distance to the long side wall and place the spacers.
- Angle the first board of the third and each subsequent row diagonally from above with the tongue in the groove of the previously installed row and lay it down with light pressure.

Attention! After locking the boards lengthwise, tap with a suitable tapping block to ensure complete locking.

- Install all subsequent boards of a row as follows:
 - ✓ To begin with, insert the longitudinal tongue diagonally from above into the longitudinal groove of the previous row.
 - ✓ In this angled position, push the board as close as possible to the front edge of the left board so that the front tongue of the board to be installed lies on the groove of the left board.
 - ✓ Then lock the longitudinal joint by lowering the board.
 - ✓ Lock the short connection by tapping it horizontally into the decor edge using a hammer and tapping block (Fig. C3b).
 - ✓ Install all remaining boards as described above, adjusting the length of the first and/or last board of any row if necessary.

4.2.3. Installation method C:

Installation in rows by angling along the short and long sides

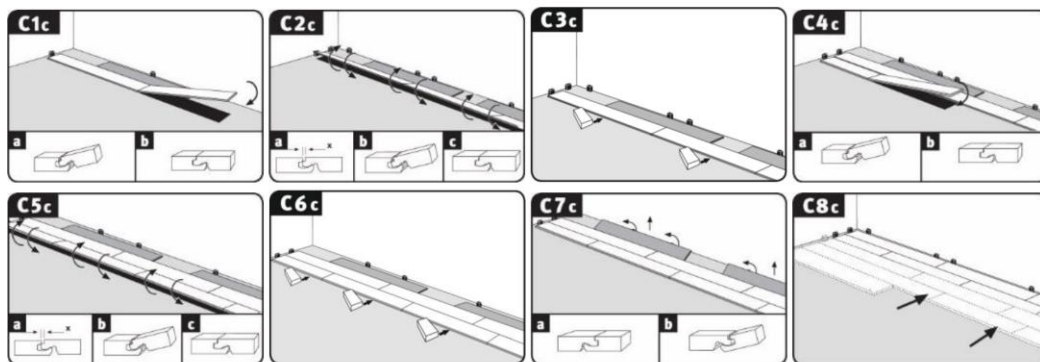

- Place the first board in the left-hand corner of the room so that both tongue sides face the wall (Fig. C1c).
- Join the boards of the first row by angling in the front tongue of the board to be installed diagonally from above into the front groove of the already installed board and lay it down with light pressure on the short side (Fig. C1c). The last board in the first row is cut to the required length and installed as specified above.
- Make sure that the boards of the first row are aligned with precision on the long side. It is recommended to place a flooring board as a stop between the wall and the first row, in the area of the end joints (Fig. C1c to C6c). After the first 2-3 rows have been installed, the stop elements are removed and the floor surface installed so that point is aligned with the wall on the long side, observing the wall distance (place spacers) (Fig. C7c and C8c).
- Install the first board of the second and each subsequent row with the long side tongue over the long side convex groove of the previously installed row without closing the joint (Fig. C3c).

See also pre-locking CLIC *it!* (YouTube)



- All subsequent boards in a row are first connected at the front end (Fig. C4c).
 - ✓ Angle in the front tongue from above into the end groove of the previously installed board and place the board (with slight pressure on the short side) as close as possible to the long edge of the installed row, so that the tongue lies over the longitudinal convex groove of the previous row.
- Close the longitudinal joint (Fig. C5c/C6c).

See also CLIC *it!* row installation (YouTube).



- ✓ Slightly lift the start board on the long side.
 - ✓ Now click the long side tongue, in this angled position and with slight pressure, into the groove of the previous row.
 - ✓ Continue this from left to right until the entire row is connected to the previously installed row and lies flat. **Note:** Pay attention that the boards are not displaced along the short sides.
- Attention!** After locking the boards lengthwise, tap with a suitable tapping block to ensure complete locking.
- Install all remaining rows as described above, adjusting the length of the first and/or last board of any row if necessary.

4.2.4. Flooring profiles and skirting boards

After finishing the proper installation of the flooring, both the necessary flooring profiles and skirting boards are installed. Assembly instructions are included with the accessories.

Note: With most types of profile, the base (sub-profile) taking the cover profile (upper profile) must be installed prior to installing the flooring.

4.2.5. Additional installation instructions

Pipe penetrations

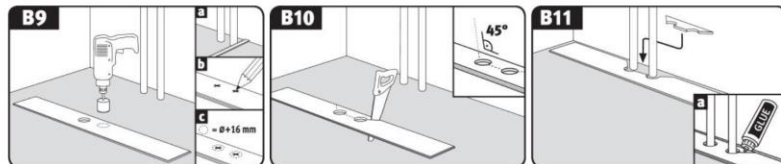

Glue = PVAC glue (D3)

- Measure the position of the pipes and mark it on the board (allow for edge joint).
- Drill at least 16 mm more than the diameter of the pipe.
- Saw the holes at a 45° angle.
- Fit and glue the sawn piece.

Door frames

- If there are door frames, it is recommended to shorten these by the installation height (flooring plus underlay materials) in consultation with the customer.
- Then install the flooring underneath the door frame by using the appropriate wall/edge joint. If the installation takes you to a door frame, the respective board can be angled in longitudinally and lowered before the frame. Then the board placed flat on the floor is tapped under the door frame into the heading joint with a hammer and tapping block and locked.
- If the door frame cannot be shortened, a standard PE joint filler profile must be inserted into the surrounding edge joint (in the area of the door frame) and sealed with silicone.

Commercial areas*

PVAC glue (D3)

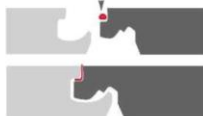

In commercial areas where an above-average exposure to moisture/liquid is to be expected, a sealing glue with PVAC glue (D3) is necessary. Apply the sealing glue to the short and longitudinal tongue in such a way that it emerges across the entire length of the joint when the boards are joined. Excess sealing glue can be removed from the surface immediately or after a brief drying period.

*Exceptions: Design Flooring GreenTec, Laminate Flooring Aqua+ and Laminate Flooring Aqua CLIC it!

Removal/dismantling of boards

To remove installed boards without destroying them, you first have to unlock the entire row by tilting it and then detach the panels at the front ends while tilted. Proceed with great care to avoid damaging the tongue and groove.

5. Installation in bathrooms*

*Excluded from use are wet rooms (such as saunas, steam baths, shower cubicles or pods, communal washrooms and swimming pool areas), application areas with permanent and increased exposure to moisture or liquids, bathrooms with floor drains and all outdoor areas.

Design Flooring GreenTec, Laminate Flooring Aqua+ and Laminate Flooring Aqua CLIC *it!* can also be installed in private bathrooms with normal household use without a floor drain with bath tub or shower tray, where the floor surface is only temporarily and briefly exposed to splashing water.

5.1. Floating installation in bathrooms

The subfloors listed below are suitable for the floating installation of Design Flooring GreenTec, Laminate Flooring Aqua+ and Laminate Flooring Aqua CLIC *it!* in bathrooms if they meet the requirements for installation suitability described under section 2.1.:

- All types of screed including hot water-heated screed
- ceramic tiles.

Furthermore, the subfloor must be properly sealed to permanently prevent moisture damage to the construction.

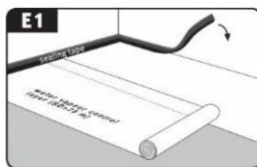

Attention: It is absolutely necessary to install the system-related moisture protection foil over the entire surface and to seal it with a sealing tape in the wall connection area in a trough shape.

Moisture protection foil and sealing tape

- The floating installation of Design Flooring GreenTec, Laminate Flooring Aqua+ and Laminate Flooring Aqua CLIC *it!* in bathrooms is carried out using one of the methods described in section 4.2., whereby the individual flooring boards are locked using the CLIC*it!* connection.



Attention:

- All expansion joints must be filled with PE joint filler (round cord) and sealed with elastic sanitary silicone to make them watertight and permanently elastic.

- When installing in rooms with a water supply (e.g. bathrooms, laundry rooms) or in the area around washbasins and sinks, washing machines, dishwashers, refrigerators and/or freezers, all movement joints to the walls, shower cubicles and pipes must be covered/sealed permanently elastic and watertight.
- It is imperative to avoid water penetration under the floor. Also skirting boards, possibly end profiles on tiled walls, door frames, etc., must be sealed to the floor with sanitary silicone to make them watertight and permanently elastic.
- Only transition, adjustment and end profiles made of aluminium may be used. The joint between profile and wall must be sealed in a waterproof manner with an elastic joint seal.

5.2. Full-surface bonding of Design Flooring GreenTec and Laminate Flooring Aqua+

The subfloors listed below are suitable for the installation of Design Flooring GreenTec and Laminate Flooring Aqua+ by means of full-surface bonding if they meet the requirements for installation suitability described under section 2.1.

1. Standard application (dry room conditions)

- all types of screed including hot water-heated screed
- woodfibre boards, OSB and chipboard structures
- ceramic tiles (system-specific base coat / filling of the tiles is required)

2. Bathroom application (wet rooms conditions)

- all types of screed including hot water-heated screed
- ceramic tiles (system-specific base coat / filling of the tiles is required)

Design Flooring GreenTec and Laminate Flooring Aqua+ can be bonded over the entire surface both in private living areas and in commercial areas. For full-surface bonding, the installation is carried out as described in section 4.2.2 "Method B: angled in at the long side and taped in at the front board by board".

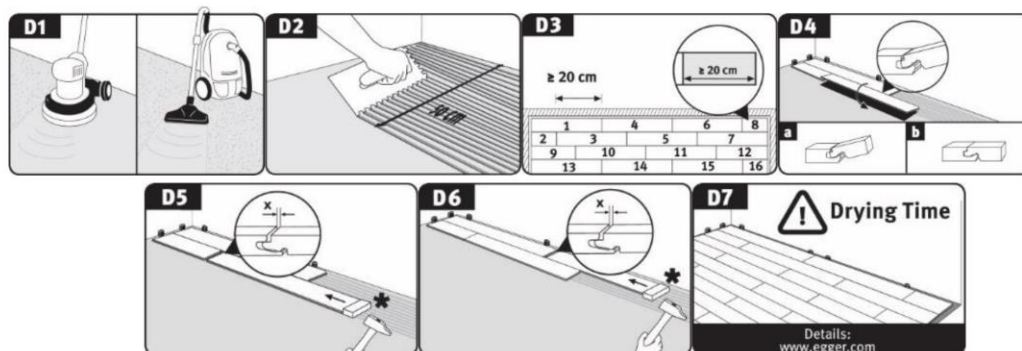

As a general rule:

- An adhesive approved by the adhesive manufacturer must be used. All specifications provided by the adhesive manufacturer, for example trowel serration, fitting and setting times, must be observed. In the case of a failure to comply, any guarantee and warranty claims will become void. An overview of approved adhesives is available at www.egger.com.
- Full-surface bonding should be carried out by a specialist (professional floor installer).
- Faulty placement in the adhesive bed must be avoided, if the levelness of the subfloor as required for installation is not achieved, a system-specific base coat and/or filling must be applied without fail. For tiled floors, a system-specific base coat and filler are always required.
- Screeds must always be sanded and vacuum-cleaned using an industrial vacuum cleaner.
- In bathrooms, the subfloor must be properly sealed before installation to permanently prevent moisture damage to the construction.
- Depending on the subfloor, the notched trowel must be replaced by a new one every 30-50 m² at the very most.
- EGGER Holzwerkstoffe Wismar GmbH & Co. KG is not liable for the correct use and processing of the adhesive system.
- In the case of full-surface bonding, motion profiles only need to be built into door transition areas / passageways if there is a functional joint included in the structure. Both areas must overlap in space, as functional structural joints must be expanded into the top floor.
- The maximum area size for full-surface bonding is determined by the functional structural joints. In this regard, the following recognised rule of the trade applies: All functional construction joints located in the subfloor may never be subjected to force-fitted closing and must be expanded into the top floor.
- Apparent/shrinkage joints in the surface as well as in door transition areas must be force-fitted after the screed has hardened and before subsequent floor covering work, e.g. by flexing them open, inserting the screed clamp/wave connectors and grouting them with synthetic resin. They do not have to be incorporated into the subsequent floor covering.
- The arrangement and specification for the execution of joints, especially movement joints, is the responsibility of the planner.

Note: Disregarding movement joints can, under certain circumstances, have irreparable consequences for the floor covering.

Attention! The drying and hardening time of the respective adhesive must be observed without fail, before the installed flooring surface is approved for use.

Provisional note:

These processing instructions were prepared based on the best available information and with due diligence. The information provided is based on practical experience, in-house testing and reflects our current level of knowledge. It is intended for information only and does not constitute a guarantee in terms of product properties or suitability for specific applications. We accept no liability for any mistakes, errors in standards, or printing errors.