

CREATIV' Line

REVÊTEMENT DE SOL STRATIFIÉ

Bâton rompu



Water Resistant*



Fabrication française

*Pas de changement d'apparence et gonflement $\leq 0,2$ mm. Test réalisé selon le protocole NALFA et la norme ISO 4760.

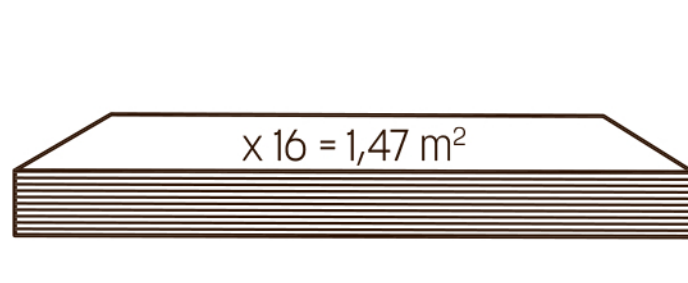
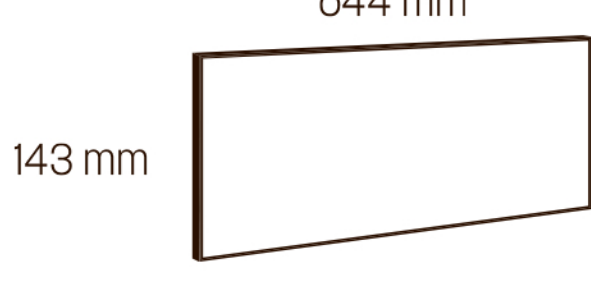

REVÊTEMENT DE SOL STRATIFIÉ

Laminate flooring | Suelo laminado | Laminatfussboden
Ламинат | Laminat parke | Pavimento laminato
Pavimentos estratificados | Συθετικό πατωμα
Panele podłogowe laminowane | 强化木地板

CLASSE D'USAGE

Class of use | Clase de uso | Nutzklassen | Класс стирание
Kullanım sınıfı | Clase di uso | Classe de utilização
Κατηγορίες χρήσεων | Klasa | 使用等级

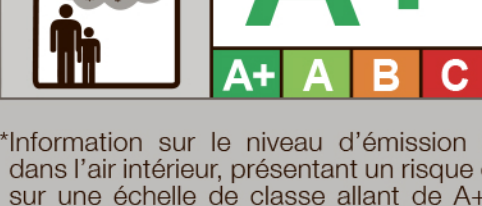
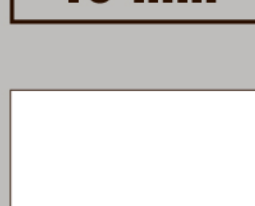

*Information sur le niveau d'émission de substances volatiles dans l'air intérieur, présentant un risque de toxicité par inhalation, sur une échelle de classe allant de A+ (très faibles émissions) à C (fortes émissions).



EN 14041 Revêtements de sols stratifiés pour usage intérieur	
Réaction au feu	Cfl-S1
Emission de formaldéhyde	E1
Glissance	DS
Conductivité thermique	$\leq 0,15$ m²K/W
N° DE DOP : 147/RPC/2022	

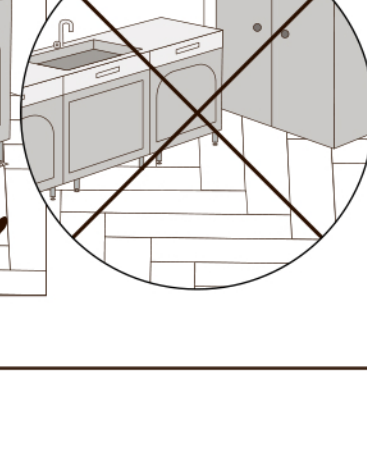
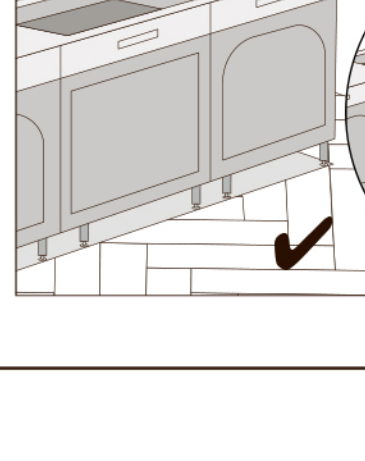
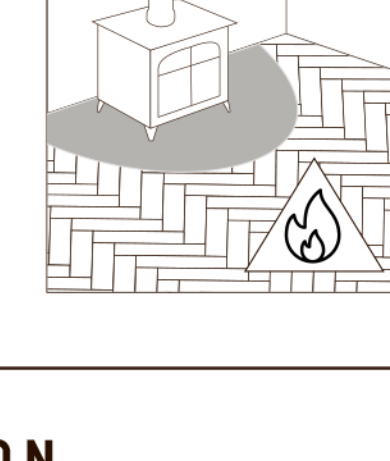
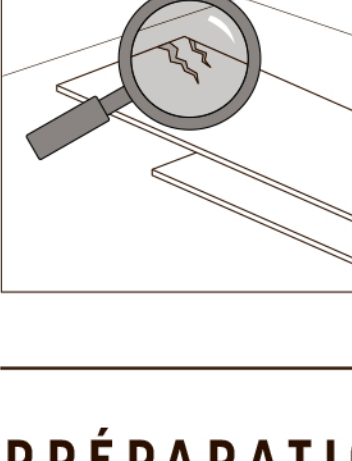
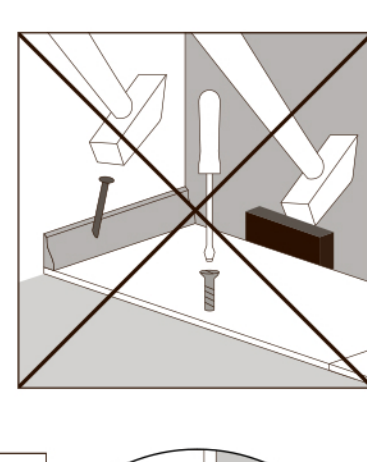
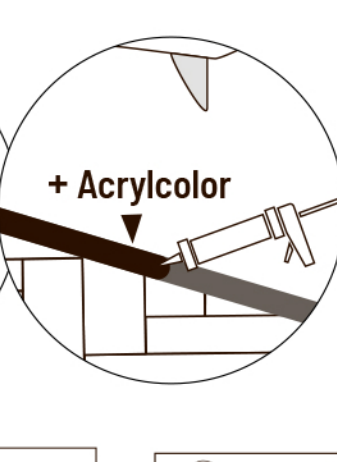
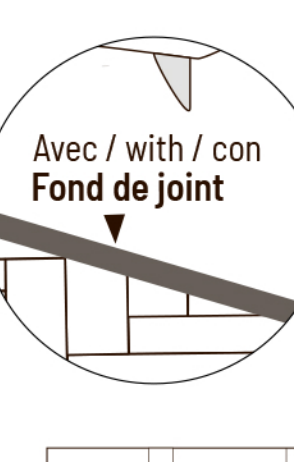
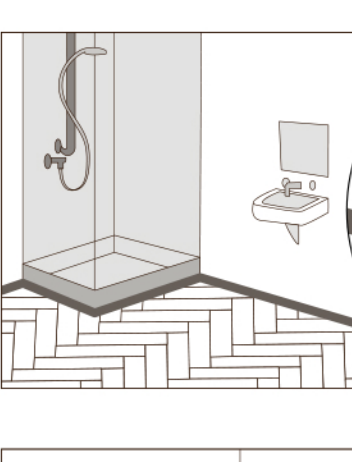

PRÉPARATION

Before laying | Antes de colocar | Vor dem verlegen | Подготовкa
Hazırlık | Prima della posa | Preparação | Τοποθέτηση | Przygotowanie
准备工作

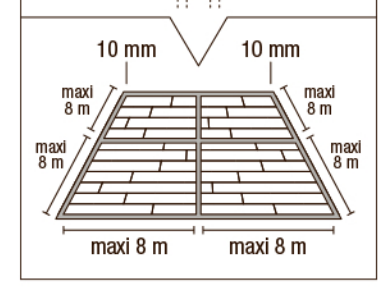
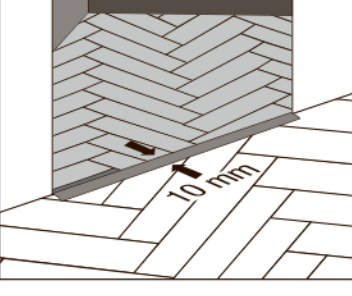
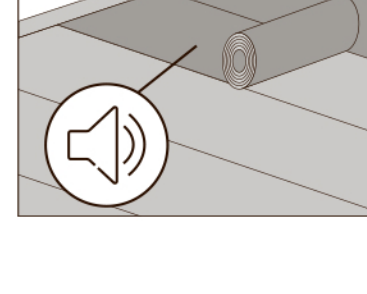
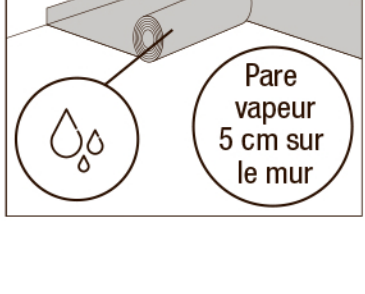
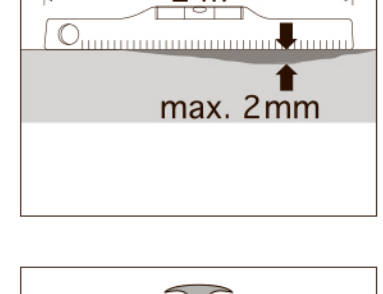
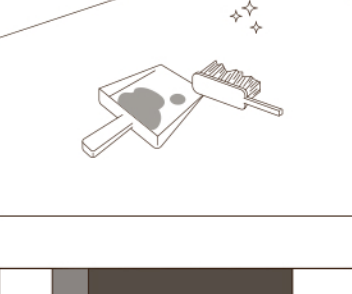
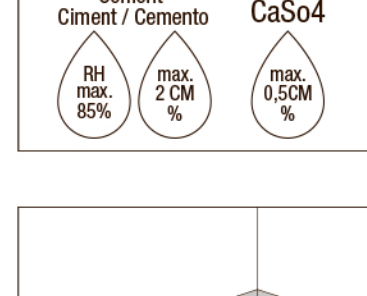
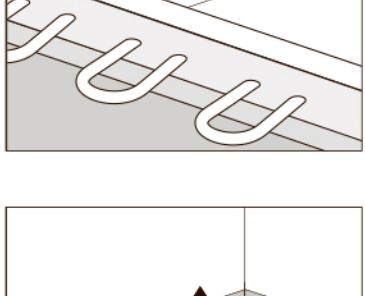
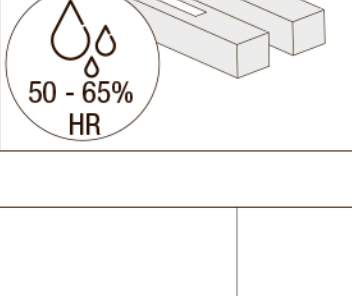

INSTRUCTIONS DE POSE

Laying instructions | Instrucciones de instalación
Verlegeanleitung | Инструкция по укладке
Montaj Talimatları | Istruzioni di posa
Instruções de aplicação | Ενδοδαπέδια θέρμανση
Instrukcja montażu | 安装说明

